

Sheet metal solutions

Radan is the total CAD/CAM solution for the sheet metal industry

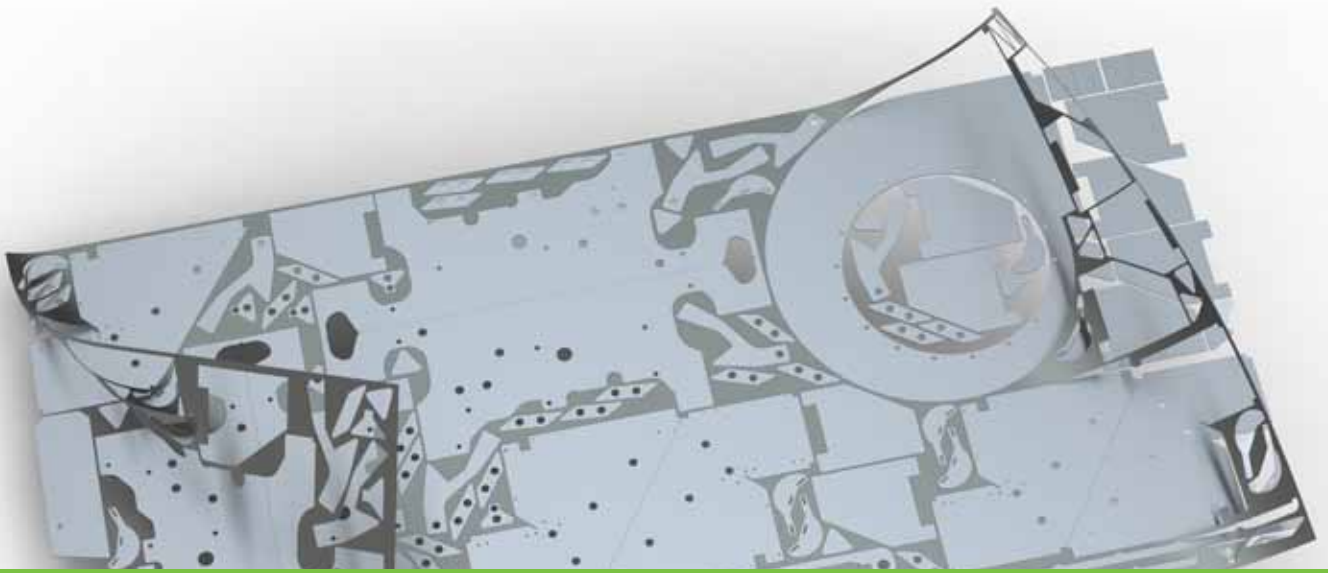

radan

The complete process...

Radan is the total CAD/CAM solution for the sheet metal industry

We understand that metal is precious in your business, and with our software your company can significantly reduce inventory and increase material utilisation, allowing you to realise true return on your investment.

Our strength is in providing world class innovative solutions that give you the software applications that are essential to design, manufacture and control production of sheet metal components and products.

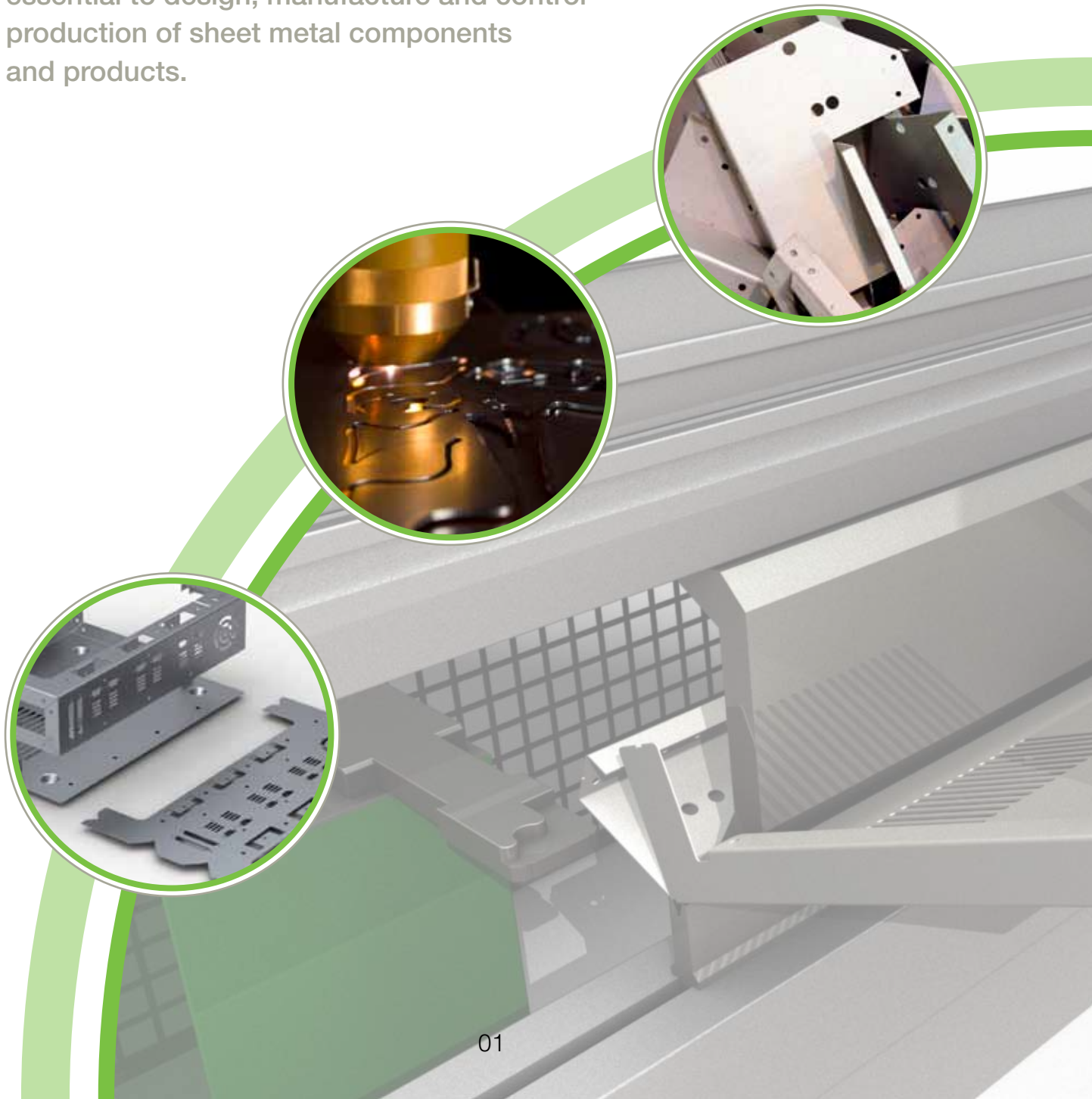

Efficiency is everything

Understanding the sophistication and the limits of each machine tool individually is the key to driving it efficiently. Radan will assist your operators to optimise your manufacturing capacity to within those limits for all of your machines.

Radan is a fast, modern programming application designed to assist a programmer in transferring data from CAD to NC code through its seamless interface and automatic processes. Unfortunately, in reality, production workflow is not always that consistent.

Problems downstream, manufacturing change requests, and reject rework requests all require an operator to be fast and efficient. Radan provides access into the programming process at the point where the change is required, but it does not necessarily demand that the whole programming process is repeated.

A machine tool is only as efficient as the software driving it. That is why we personally install every Radan post processor to ensure that it is commissioned to match your machine tool and controller. It's controlling your production efficiency - that's why your software is important to us.

Seamless programming

Radan seamlessly integrates the whole programming process of geometry creation, tooling, nesting, sequencing, code generation and finally DNC connectivity to the machine controller. This formidable combination will expand with you to program all your future punch, laser, plasma, router and combination machine tool investments from one system.

The seamless integration delivered by Radan provides an easy to use experience for your operators, whilst accuracy and consistency of programming is maintained with the collation of process critical data in the Manufacturing Database (MDB). Material, tooling and machine tool specific data are stored in the MDB ready for instant distribution when required to assist an operator or automated process.

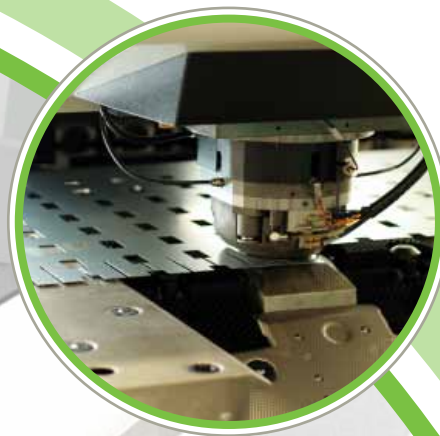

Punching

CNC programming for all your punch machines

Radpunch is machine independent and supports all major manufacturers such as Amada, Baykal, Durma, Ermaksan, Euromac, Finn-Power, LVD Shape, LVD Strippit, Murata, Nisshinbo, Prima-Power, Pullmax, Rainer, Shape, Strippit, Tailift, Trumpf, Whitney, Wiedemann, Yawei Nisshinbo and many others.

Radpunch is designed to provide operators with the tools they require to reduce lead times and optimise punching machines. Radan nesting extends Radpunch functionality to provide true shaped nests that produce high utilisation, manufacturable nests from sheets, off-cuts and remnants delivering substantial savings in material.

Designed to seamlessly integrate with Radprofile, the Radan punch/profile solution delivers optimisation for punch, profile and combination machine tools. This formidable combination will expand with a customer to program all their future punch, laser, plasma, router and combination machine tool investments from one system.

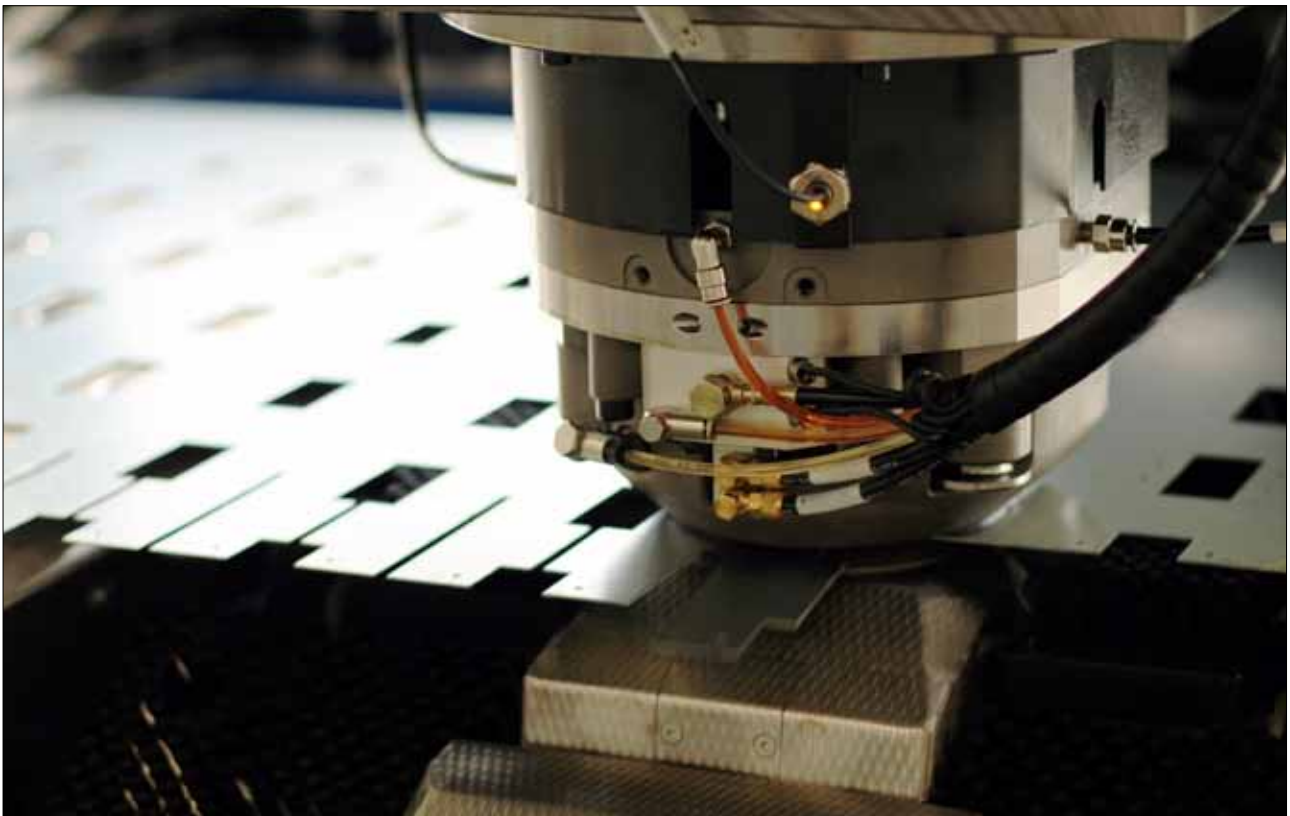

Radpunch is the market leading solution for programming punching machines. With over 35 years of punching experience, Radan successfully drives thousands of punching machine tools worldwide.

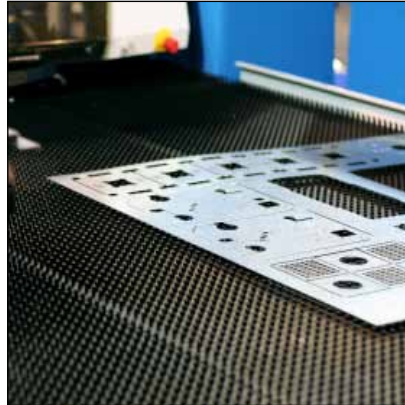

Tooling optimisation

Optimising the tooling is paramount to the efficient programming of a punch machine, thus reducing the cost of manufacturing a part. Simply optimising conventional tools on a part and their location in the turret or tool rail is no longer sufficient, as tooling suppliers are providing more sophisticated tooling such as close to clamp slitters, wheel tooling, de-burring tools, scribes and flexible part marking tools. Radpunch understands the constraints of tools and the necessary NC codes required to support them.

Radpunch's orientation specific tooling permits multiple tooling setups to be applied to a part for different nesting orientations and different machine tools. This enables the downstream nesting process to fully optimise material utilisation by part rotation, which may have otherwise been restricted due to tool rotation limitations. The same functionality also optimises preparation of parts for removal processes on more sophisticated machine tools. Whilst a part may be capable of dropping down a chute or being picked at one orientation, at another orientation it may not be suitable. Orientation specific tooling enables the appropriate part removal processes to be applied to complement the part orientation during nesting.

To minimise programming lead time, identification and manipulation of tooling is paramount to an operator. Radpunch provides this capability with the user customisable interactive tool list.

The easy to use interface enables an operator to quickly identify and interact with tooling at process critical stages.

Power and control

The power of automation with the ability to control by your preferences. The Radpunch programming solution provides your operators with easy to use software that can be educated to adopt your preferred practices and processes. Tool selection, tagging, preferred removal procedures, preferred punching sequences - all these and more can be defined relative to material type, thickness and machine tool in the Manufacturing Database. The MDB expands with your business. The introduction of new customers, new products or new machines brings into your manufacturing environment the need to control new material, tooling and new practices. The MDB ensures consistency of programming for these new criteria for all your machines, which translates to fewer rejects, less rework and higher returns.

If manual control is your preference, Radpunch has this in abundance, enabling an operator to take full control of the programming process at any stage. The ability to interact manually and override any of the automated processes gives a Radpunch user the power to tackle the most difficult jobs with ease and confidence.

The fully integrated Project Nester provides an instantaneous overview of punching demand. Automatic rectangular nesting, single part true shape nesting and manual drag and drop nesting techniques enable your operator to quickly, easily and efficiently meet your ever changing production and customer demands. If material utilisation is critical to your business, upgrading the nester to our true shape nester, Radnest, will raise your material utilisation whilst also providing further advanced nesting tools.

Features include

- Drag and drop data input
- Batch processing of DXF/DWG including healing
- Automatic tooling/sequencing
- Automatic part removal
- Graphical program verification
- Single part true shaped nesting
- Project nesting incorporating user definable reports
- Quick estimates for parts or nests
- Simple intuitive interface with clear simple icons
- Supporting machines' advanced features
- Improved machine/tooling efficiency
- Reduced lead times and increased production

Profiling

CNC programming for your laser, plasma, water jet and flame cutting machines

Radprofile is the market leading solution for programming profiling machines. Having driven the first profiling machines to be introduced to the market, Radan now successfully drives thousands of profiling machine tools worldwide. The Radan punch/profile solution delivers optimisation for punch, profile and combination machine tools.

Radprofile intelligently applies the profile tool paths at the nesting stage to maintain the quality and integrity of your parts, whilst also optimising the cutting sequence and ensuring cutting head safety, thus enabling the machine tool to perform to its optimum potential.

All profiling solutions are machine independent and support all major manufacturers such as Adira, Adige, Amada, Balliu, Bystronic, Cincinnati, Cutlite, CY Laser, Hankwang, LVD Strippit, NTC, Mazak, Mitsubishi Electric, Prima Industrie, Prima-Power, Salvagnini, Strippit, Trumpf and many others.



Radprofile brings advanced CNC profiling to the Radan family. Combining sophisticated technology with a high level of automation, Radprofile delivers maximum productivity for your engineering staff and machine tools.

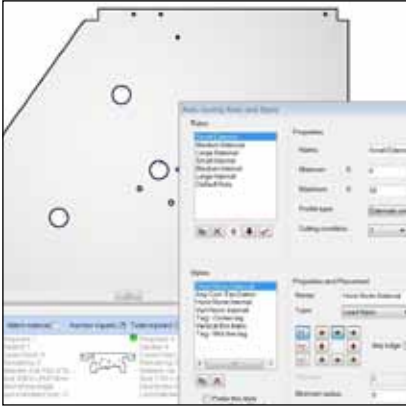

Process optimisation

Optimising the tool path, cutting technologies and cutting sequence for a profiling machine is paramount to the efficient programming of the machine and thus reducing the cost of manufacturing a part. As profiling machines, particularly laser profiling machines become faster and more sophisticated, the integrity of the part in the nest sheet and the safety of the machine head become even more paramount. Radprofile intelligently applies the profile tool paths automatically at the nesting stage to maintain the quality and integrity of your parts, whilst also optimising the cutting sequence and ensuring cutting head safety, enabling the machine tool to perform to its optimum potential.

Radprofile supports automatic common line cutting. This enables the downstream nesting process to fully optimise material utilisation, whilst also benefitting from reduced cutting times and assist gas costs. Parts identified for common cutting can be controlled to cut in clusters to maintain sheet rigidity and remove tolerance problems associated with common cutting in large quantities.

Power and control

The power of automation with the ability to control by your preferences. The Radprofile programming solution provides easy to use software that can be educated to adopt your preferred practices and processes. Lead-in and lead-out preferences, tagging, preferred profiling sequences - all these

and more can be defined relative to material type, thickness and machine tool in the Manufacturing Database. The MDB expands with your business. The introduction of new customers, new products or new machines brings into your manufacturing environment the need to control new material, strategies and new practices. The MDB ensures consistency of programming for these new criteria for all your machines, which translates to fewer rejects, less rework and higher returns.

If manual control is your preference, Radprofile has this in abundance, enabling an operator to take full control of the programming process at any stage. The ability to interact manually and override any of the automated processes gives a Radprofile user the power to tackle the most difficult jobs with ease and confidence.

The fully integrated Project Nester provides an instantaneous overview of profiling demand. Automatic rectangular nesting, single part true shape nesting and manual drag and drop nesting techniques enable your operator to quickly, easily and efficiently meet your ever changing production and customer demands. If material utilisation is critical to your business, upgrading the nester to our true shape nester, Radnest, will raise your material utilisation whilst also providing further advanced nesting tools.

Benefits

- Maximise material utilisation with single part layout and automatic nesting
- High productivity for engineers and machine tools
- Reduced lead times
- Increased production flexibility.
- Easily switch production from one machine tool to another
- Only one software package needed to drive all your machine tools
- Support for your machine's advanced features
- Efficient data exchange for sub-contractors

Features include

- Easy to use Windows interface with drag and drop data exchange batch processing from DXF, DWG or IGES files
- Fully automatic profile setup
- Flexible support for lead-in, lead-out, tagging and overburn
- Drag lead-ins and lead-outs to desired location
- Smart lead-in placement for maximum safety
- Material database including cutting parameters
- Fully automatic multi-part nesting.
- Cutting sequence optimisation with hazard avoidance
- Automatically cost parts with Quick estimates

Multi-Axis Profiling

Multi-axis laser technology for 3D sheet metal components

Radtube is an industry leading Laser CAD/CAM system for rotary and multi axis cutting machines developed specifically for the tube cutting industry.

Radm-ax has been developed specifically for the general engineering, automotive and aerospace industries with a wealth of in-built features that allow for the optimisation of the laser toolpath.



Radtube

Library of standard tube sections

Radtube supplies a library of parametric tube shapes that simplify the creation of the tube material to be cut. If a suitable section does not exist, the 'freeform' option is used to create the special shape section. Freeform shape tubes can even be created from one of the libraries of Radtube parametric shapes. If none of these standard shapes are suitable, the user simply draws the section centre line profile or outside / inside shape using the integrated CAD tools.

Library of standard shapes

In a similar way to tube sections, Radtube supplies a library of parametric hole shapes, again with the option to define 'freeform' shapes; so specialist joint features such as duck tails, clips and key holes are easily added. Holes in the tube are created by generating a solid object to represent the shape, which is then extracted from the tube. The solid can pass through all walls or one wall and can pass through the edge of the section creating a gap.

For holes passing through the tube section at a single or compound angle, positioning can be defined at the mid-point of the section or at a position on the top face. For hole shapes that repeat along the tube in a standard pattern, five pattern shapes are supported: Circle, Line at an Angle, Arc, Square and Grid.

Nesting multiple parts

Where a number of small parts can be produced from a common tube section, it is possible to use the Radtube nesting option. This allows the user to create individual programs for each part (including cutting path), simulate and check the cutting path. Parts of suitable section are then selected and the quantity required

specified. New parts and quantities are added until Radtube reports that the material length specified is full. As each part is selected, Radtube automatically checks the section of the material and reports if it is a suitable part for the nest.

Radm-ax

Automated fixture design

Stamped forms typically need to be held using fixtures and within Radm-ax this can be done in a number of ways. One way is to import clamps and fixtures from external files and then manually reposition them. Another way is to use the Fixture Design utility to create the support fixtures using sheet metal. Simply define the number of horizontal and vertical support sheets, how they interlock - including locking features if you require them - and how they run-off the part. Once these details have been defined, Radm-ax creates each sheet, nests them on standard sheet metal sizes, adds assembly notes such as number references and creates the NC code with which to manufacture them.

Reduce machine wear

Radm-ax has a wealth of in-built features that allow for the optimisation of the laser toolpath. For example, by smoothing out the toolpath in areas around tight corners or small features, Radm-ax will optimise the toolpath to reduce wear on the machine tool at the same time; ensuring that feeds and speeds are maintained across the job.

Cutting-path creation

Cutting operations can generally be divided into two areas: inner and outer trims. Outer trims are the external forms of the part whilst inner trims represent the internal cut-outs and other features to be machined. The basic toolpaths for these cutting operations are automatically created.

User interaction is available for all toolpath types to allow for manual creation and refinement. Radm-ax provides a great amount of control over how each inner or outer trim is handled; for example, creating micro-joints to hold the material in place until processing is finished becomes quick and uncomplicated. The toolpath can also be edited in terms of how the cutting nozzle is angled towards it or how it handles jigs and fixture features.

Toolpath verification and simulation

Within Radan the toolpaths are presented showing the angle of the nozzle as it moves around the part. Instant feedback is provided about whether or not a specific move is possible - either in terms of machine head movement limits or accessibility. Any collisions that are detected are highlighted both on the model and via on-screen messages.

The trim-path parameters can be edited directly or, in the event of a collision, automatically corrected at any time; ensuring that your toolpath is both safe and using the optimum strategy to reduce processing time. Once the toolpath has been optimised, simply select the piercing and cutting conditions from the pre-defined technology tables and quickly generate reliable NC code.

NC code simulation

The NC code can be re-imported into Radan and simulated within the same environment in which it was created. The NC simulation shows how the tool moves through space, allowing the toolpath to be sanity checked before any metal cutting occurs.

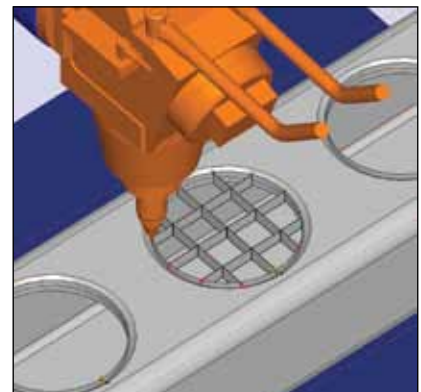
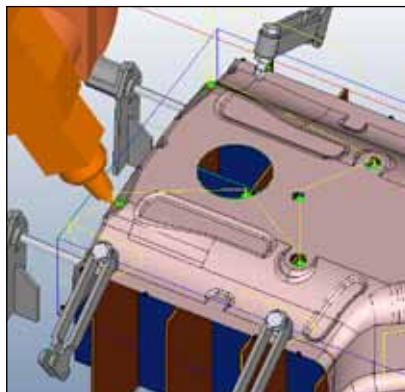
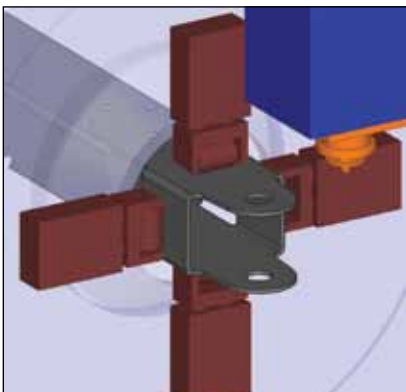

Combination

CNC programming for your laser, plasma, water jet and flame cutting machines

Combi is the perfect solution for customers utilising both punch & profile technologies. Designed to satisfy independent punch & profile requirements and also providing a seamless transfer of parts between them. Having this flexibility allows customers to switch the manufacturing process to suit their production or even to eliminate capacity issues.

Having a Combi solution ensures that customers no longer have to duplicate expensive programming time to transfer from one technology to another.

Combi is machine independent and supports all major manufactures such as Adira, Adige, Amada, Balliu, Baykal, Bystronic, Cincinnati, Cutlite, CY Laser, Durma, Ermaksan, Euromac, Finn-Power, Hankwang, LVD Shape, LVD Strippit, Murata, NTC, Nisshinbo, Mazak, Mitsubishi Electric, Prima Industrie, Prima-Power, Pullmax, Rainer, Shape, Salvagnini, Strippit, Tailift Trumpf, Wiedemann, Yawei Nisshinbo and many others.



Combi also offers a total solution for customers who use a single machine covering punch and profile technologies. The extensive functionality of both Radpunch & Radprofile are combined into a single solution for your current and future punch and profile machinery.

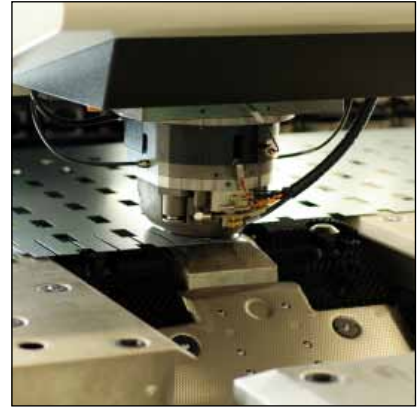
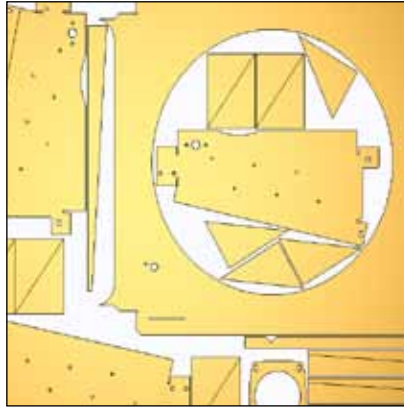

Tooling optimisation

Optimising the tooling is paramount to the efficient programming of a punch machine, thus reducing the cost of manufacturing a part. Simply optimising conventional tools on a part and their location in the turret or tool rail is no longer sufficient, as tooling suppliers are providing more sophisticated tooling, such as close to clamp slitters, wheel tooling, de-burring tools, scribes and flexible part marking tools. Radcombi understands the constraints of tools and the necessary NC codes required to support them.

Radcombi's orientation specific tooling permits multiple tooling setups to be applied to a part for different nesting orientations and different machine tools. This enables the downstream nesting process to fully optimise material utilisation by part rotation, which may have otherwise been restricted due to tool rotation limitations. The same functionality also optimises preparation of parts for removal processes on more sophisticated machine tools. Whilst a part may be capable of dropping down a chute or being picked at one orientation, at another orientation it may not be suitable. Orientation specific tooling enables the appropriate part removal processes to be applied to complement the part orientation during nesting.

To minimise programming lead time, identification and manipulation of tooling is paramount to an operator. Radcombi provides this capability with the user customisable interactive tool list. The easy to use interface enables an operator to quickly identify and interact with tooling at process critical stages.

Radcombi supports automatic common line cutting when profiling. This enables the downstream nesting process to fully optimise material utilisation, whilst also benefiting from reduced cutting times and assist gas costs. Parts identified for common cutting can be controlled to cut in clusters to maintain sheet rigidity and remove tolerance problems associated with common cutting in large quantities

Seamless programming

Radcombi seamlessly integrates the whole programming process of geometry creation, tooling, nesting, sequencing, code generation and finally DNC connectivity to the machine controller. The seamless integration delivered by Radcombi provides an easy to use experience for your operators, whilst accuracy and consistency of programming is maintained with the collation of process-critical data in the Manufacturing Database (MDB).

Material, tooling and machine tool specific data are stored in the MDB ready for instant distribution when required to assist an operator or automated process. Understanding the sophistication and the limits of each machine tool individually is the key to driving it efficiently; Radcombi will assist your operators to optimise your manufacturing capacity to within those limits for all of machines from a single system.

Features include

- Drag and drop data input
- Batch processing of DXF/DWG, including healing
- Automatic tooling/sequencing
- Automatic part removal
- Graphical program verification
- Single part, true shaped nesting
- Project nesting incorporating user definable reports
- Automatic common line cutting
- Automatic remnants, sheet scrapping and off-cuts
- Quick estimates for parts or nests
- Simple and intuitive interface with clear simple icons
- Supporting machines' advanced features
- Improved machine/tooling efficiency
- Reduced lead times and increased production

Nesting Efficiency

Advanced true shape nesting

Radnest is a highly efficient nesting package that enhances either Radpunch or Radprofile. Incorporating fully generalised nesting that analyses the true shape of components, Radnest can dramatically increase sheet utilisation and deliver substantial material cost savings.

By using Radnest, you can expect to produce more components from less material a shorter time. The efficiencies gained have a significant effect on profit, enabling you to manufacture parts from material that would have previously been in the scrap bin.



Radnest analyses the true shape, material and thickness of all components in a batch, separating and sorting automatically, producing high utilisation, manufacturable nests from sheets, off-cuts and remnants, delivering substantial savings in material and improving machine efficiency.

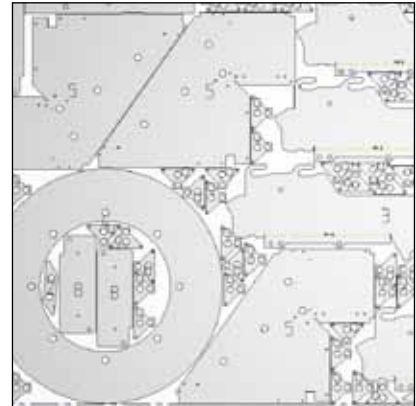
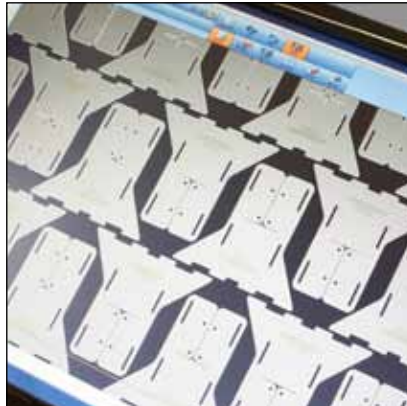
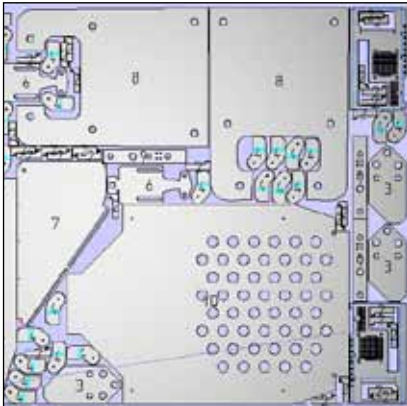

Radnest for punching or profiling

Radnest is a high performance true shape nester for punching and profiling machines, supplementing the nesting utilities present in a standard Radan system, allowing the user to have full control over part placement and nest generation either manually, semi-automatically or fully automatically. Radnest can dramatically increase sheet utilisation and significantly reduce the time taken to create nests.

Radnest allows 2D profiles to be imported en masse, setting attributes such as material, thickness and quantity to be set as part of the quick and easy process. Files can be cleaned and healed on import, removing drawing borders, text and dimensions whilst closing small gaps and removing rogue geometry. Preferences can be saved into templates, allowing you to tailor your import to your customers' data.

Kits can be created within Radan, helping to avoid parts from being missed from assembly lists. Simply enter into Radnest which kit you would like to manufacture and how many. Radnest will then explode the kit into its component parts with the correct materials, thicknesses and quantities.

Profiling with Radnest

When used with Radprofile, Radnest can automatically produce common line cuts between adjacent parts to further increase material utilisation

and reduce cycle time. Gaps between components are controlled by the kerf width created by a given material, thickness and cutting method for a specific machine. This data is stored within Radan, meaning that complete automation is possible. Radnest is able to mix different nesting techniques on the same sheet, whether that means rigid kits, picking clusters, common cutting or standard spaced. The result is industry leading results for today's modern machinery and manufacturing techniques.

Advanced nesting for punching machines

When Radnest is used with Radpunch, the tooling for each part is compared against the available stations in the turret or tool changer. This may restrict the orientations at which a part can be placed or mean that a different part is selected for the current nest. It is extremely important that the nest produced does not exceed the tooling capacity of the machine tool, as this would result in a program that could not be run.

Radnest can analyse the geometry of punch tools used on parts, enabling accurate spacing of components based on the distance between tool hits rather than the conventional part spacing. This allows parts to be nested closer together whilst still maintaining rigidity in the sheet and removing the danger of large external tools entering a neighbouring part.

Reading the data stored on Radan geometry is another way that Radnest improves the accuracy and reliability of nesting within an organisation. Radan parts can have orientation restrictions, common cutting rules and removal data embedded onto them for any machine tool. Radnest is able to extract this data and use it in context, based on the machine the nest is being created for. Radnest enables manufacturing flexibility that is unrivalled in our industry by using the information available to create the best manufacturable nest possible for any punching or profiling machine.

Features include

- Increased material utilisation with the ability to prioritise sheets
- Improved machine efficiency
- Automatic material sorting
- Automatic remnant usage and tracking
- Easy integration and inclusion into your current work flow
- Machine specific nests with associated CAM rules
- Simple intuitive interface with clear and simple icons showing status

Bending

Offline programming and simulation for press brakes

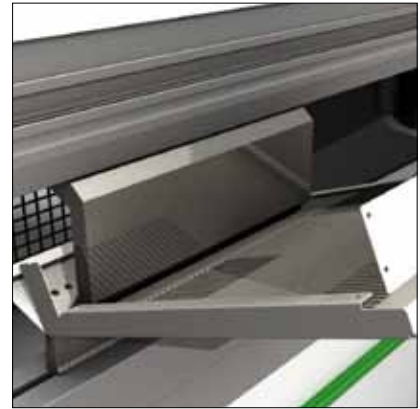
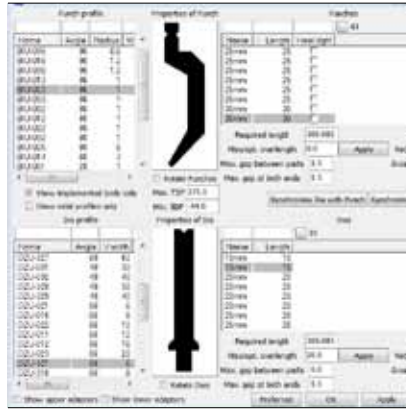

Offline programming

Radbend enables full and accurate 3D-model simulation of the bending process, including advanced features such as automatic bend sequence calculation, automatic tool selection and automatic finger stop placement, offering simple programming and high productivity.

The ability to program and verify bending operations offline frees up valuable machine time and improves first-off reliability, reducing manufacturing costs. Radbend also eliminates costly mistakes with automatic detection of collisions with both tooling and the machine tool itself.

Radbend is available to provide offline programming and simulation of a wide variety of press brake machinery. Radbend can create full shop floor documentation in print form or a file for viewing on a shop floor viewer and DNC system, ensuring access to only controlled data from production office through to shop floor, resulting in a 'right first time' manufacturing approach.

Highly automated

Radbend features high levels of automation. The system examines the part to be programmed and automatically determines a bending sequence, taking into account part geometry and best machinery practice.

In addition, finger stop positions are set automatically to provide reliable positioning.

Radbend's tooling library can incorporate a tooling manufacturer's complete inventory, enabling non-standard tools to be tested and proven on new products before purchase.

Machine independent

Radbend is totally press brake independent. Users are able to program all their press brakes from one common interface. This offers great flexibility, where users can quickly try out several press brakes to ensure the right machine for the job.

Autodesk Inventor plug-in

Autodesk Inventor can be fully integrated with Radbend using the plug-in. The Radbend plug-in offers a seamless, accurate and intelligent transfer of data between these two programs.

Taking your part from Autodesk Inventor into Radbend couldn't be more straightforward. Once you are satisfied with your design, simply click on the Radbend icon, and your part and associated information gets transported into Radbend.

SolidWorks plug-in

Utilising the Radbend Plug-in, taking your part from SolidWorks, Standard, Professional or Premium couldn't be more straightforward. Once you are happy with your design, simply click on the Radbend icon, and your drawing and associated files are seamlessly transferred into Radbend.

Increase productivity

Once your part has been transferred into Radbend you will be able to:

- Select the most appropriate machine tool and the appropriate tools to bend the part correctly
- Check the consequences of your tool set up - expected radius, press depth, etc
- Automatically position finger stops against every valid face requiring fingerstops
- Run a full 3D simulation of the bending process, detecting any collisions and potential problems
- Automatically generate complete shopfloor documentation, including setup sheets

Press brake independent, Radbend can reduce bottlenecks and costs, whilst increasing efficiency and productivity by enabling you to program and verify your bending operations offline, as well as detecting any collisions with the tooling, finger stops and the machine tool itself.



Design

3D sheet metal design and automatic unfolding

Radan3D is a simple to use 3D design tool. It is ideal for the design of sheet metal parts and assemblies. However it doesn't have to stop there, Radan3D is an all round 3D modelling tool that can handle all your 3D design and modelling requirements.



Radan3D is a high performance and versatile 3D modelling package designed to make sheet metal design and engineering assembly modelling simple.

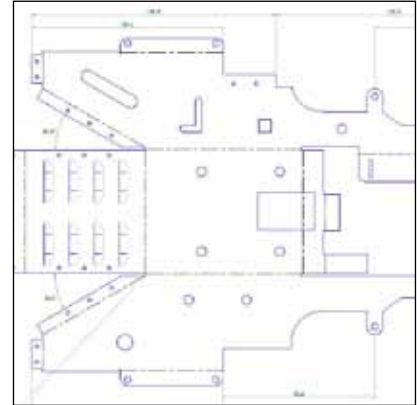
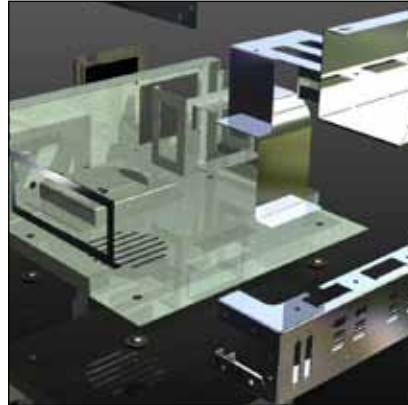

3D sheet metal design

The software is specifically focused on the rapid creation and modification of 3D sheet metal parts and assemblies. The system understands the attributes of sheet metal and utilises user-definable parameters for precise automatic unfolding. Radan3D provides design flexibility, and a unique 2D-to-3D method of creating 3D objects.

In addition, Radan3D allows the import of a range of file formats, including Inventor, Solidworks, Catia V4 & V5, SAT, IGES, STEP and Parasolid, as well as the creation of assemblies in the 3D environment.

The Radan3D model can be updated with manufacturing information such as expected radius and setback values, from Radbend, Radan's offline programming solution.

Automatic unfolding

Parts can be unfolded directly into the sheet metal part editor, ready for onward processing. This enables a smooth and efficient workflow from design to manufacture.

Unfolding parameters, such as bend allowances, can be controlled independently of the geometry, enabling an accurate development that is based on actual bending machines and tooling to be used in production. This leads to more accurate flat blanks, more accurate folding and ultimately, a higher quality product.

Sheet metal unfolding

The unfolders can flatten models, such as intersecting cylinders, producing complex profiles in the developed shape. In order to manufacture such shapes efficiently on CNC machinery where the cutting entities available are typically lines and arcs, the software can automatically translate these complex profiles into a series of lines and arc elements. The process is designed to create the minimum number of geometries necessary to make the part to the required accuracy. The benefit is shorter programs and better quality parts.

Full assembly modelling

Radan3D is ideal for modelling simple or complex assemblies. Parts can be grouped together in assemblies or sub-assemblies within the model or can be saved and used across multiple models and assemblies. Radan3D supports both the Bottom Up and Top Down approach to 3D modelling

Bottom up

Radan3D can be used in the Bottom Up approach. This means the user can design each part in isolation and then bring them all together to form large assemblies.

Top down

Alternately Radan3D can be used in a Top Down approach. This means that the user can work within the assembly designing parts in context, ensuring correct function and fit.

Fold up from flat

Radan3D has a powerful utility that allows users to take existing 2D blanks and fold them up into 3D sheet metal models. Working from your bend allowances the Fold Up from Flat utility will scan any 2D blank drawing looking for external profiles and bend lines. It will then create an accurate 3D sheet metal model from this 2D drawing.

Once created this model can be edited in the normal way. This really is the most productive way to re-engineer existing blank data.

Tool detailing

The unique multi view feature in Radan3D offers the user the ability to turn 2D orthographic views into a 3D model.

Simply extract profiles from an existing 2D drawing or draw 2 or more 2D views of an object, press the button and Radan3D will convert these views into a 3D model. It really is the quickest and simplest way to go from 2D to 3D.

eQuote

Fast, accurate quotations for sheet metal components and assemblies

eQuote has been specifically designed for the sheet metal industry, for the fast efficient quoting of sheet metal parts. Utilising Radan's extensive manufacturing capabilities allows eQuote to arrive quickly at accurate costs and professional quotations for the typical multiple operations involved in production. eQuote also works without CAD data by simply adding the basic part information and any operations and materials required, but utilising CAD data automates a lot of these sequences.

eQuote is an automated cost estimation and quotation system for sheet metal parts. It offers simplicity and unprecedented ease-of-use, while utilising an advanced manufacturing operations modelling engine to produce reliable and consistent results.

eQuote is fully integrated within Radan and is available as an optional module to augment any of our systems. It can be used to generate estimates of any sheet metal part regardless of origin, making it as easy to cost imported parts as one modelled and unfolded in Radan3D.

Every manufacturing organisation is different and works in a different way. eQuote is designed to accommodate your unique setup by enabling complete configuration of all material and operation costs. Out of the box, example operations are provided within eQuote to support a complete range of sheet metal manufacturing operations such as punching, laser cutting and folding, but you can create additional operations of your own to suit your specific needs.

eQuote enables overheads to be modelled and attributed to parts in a variety of ways and also allows additional operations such as painting, deburring or welding to be added.

Integration

eQuote is tightly integrated to the Radan system to provide a seamless process between part preparation and estimating and quotation. Activating eQuote on the current part initiates the analysis process and starts the eQuote module where manufacturing operations can be reviewed and the cost estimate calculated.

Automation

Using eQuote is easy. The eQuote command button is available within Radan's part editor and once activated, the process runs completely automatically.

With a complete manufacturing operations model, eQuote is able to calculate the part cost and instantly provide a complete operations breakdown report and cost analysis. The analysis shows you exactly how the cost estimate was generated. This means that you can be confident about the part cost produced and it also enables meaningful adjustments to be made to global parameters and costs.

Finally, eQuote can generate a printed quotation in a flexible format by automatically accessing and merging customer information from its database.

Benefits

- Single-click estimate and quotation generation
- Automatic component analysis
- Sophisticated process modelling
- Automatically generated tooling and bending operations
- Fully configurable to your manufacturing setup
- Operations and costs tailored to your requirements
- Additional operations can be added
- Customisable quotations to suit company branding

eQuote offers additional advantages in multi-machine tool environments where parts can be produced on a number of alternative machines. In Radan, it's easy to prepare parts for several machines, either punch or profiling, and then use eQuote to compare manufacturing costs. You can produce a part cost estimate and personalised quotation letter ready for printing in just a few seconds.

e2i

Everything you need to manage a sheet metal production environment

e2i is production management for sheet metal environments. Incorporating all the power of eQuote and adding order management, shop floor routings, stock control, purchasing and everything else you will need, right up to producing the invoice and transferring it to your accounts system.

Multipurpose management

Built on a robust industry standard Microsoft SQL database, e2i encompasses the processes faced by all manufacturing companies, enabling the tracking and management of cost throughout design and manufacture, with the added benefit of being integrated into Radan CAD/CAM. Developed to meet the needs of sheet metal subcontractors but equally at home in any production environment.

Keeping things simple

When paired with a supported accounts system, data is easily transferred, avoiding manual errors.

Standard components

A typical e2i system comprises a standard server core. The only option for this is stock control. Standard components within the core in addition to those provided by eQuote are Sales Orders, Route Cards, Nest Routes, Purchasing, Capacity Planning, Deliveries and Invoicing, where a system has stock control enabled. All e2i clients have access to all core components at all times. Shop Floor Data Capture (SFDC) can be used to close the loop back to the original time estimates, allowing comparisons of actual times to estimated and to track components through the production process.

Features include

- Unique links to Radan CAD/CAM
- Advanced functionality for nesting operations
- User level security
- Simplified stores module
- Capacity planning
- Flexible stock control
- Accounting links
- Assembly and BOM management
- All records easily retrievable



Radimport

Automated import and processing of geometry data and requirement data

For most sheet metal working companies, the work preparation of parts for nesting is very time-consuming. With Radimport, geometry files are automatically converted to tooled Radan parts. With the same mouse click, your selection of geometry files can be converted to a nest project.

Flexible input

With Radimport you can select multiple DXF or DWG files and add or edit the additional information. Importing files can also be done with a configurable parts list in a CSV format, as you might get from an MRP system.

Just what is needed

Based on the feature type, layer, line type or colour, features can be changed or deleted. You just keep the information that is needed for cutting. At the same time, geometry errors can be fixed - like closing profile gaps and removing double lines and arcs. Text information can be transferred to attribute values: for example, material, sheet thickness and customer name.

Production information

Extra information can be added automatically to the part attributes. You can also engrave the article number, order number or bend line on a laser.

Optimum output

After the geometry conversion, the parts can be saved as Radan parts or as an optimised clean DXF file. All information like run time, weight and surface area can be saved as attributes in the part.

Nesting

Radimport can create a Radan Nest Project from the parts you have imported. You have the option to edit the quantities and other properties of the parts before creating the Nest Project. Radimport can automatically launch the Radan Nester to start nesting straight away.

Benefits

- Batch import DXF files
- CSV lists from MRP
- Geometry healing
- Properties from DXF or CSV
- Split multiple parts in same drawing
- Creates Radan Parts
- Creates clean geometry DXFs
- Send parts to Radan Nester
- CSV log file for MRP feedback
- Automatic processing of watched directory
- Manual overrides



Support Solutions

Peace of mind with Radan software

The financial cost of unplanned downtime can be expensive. No-one wants delayed deliveries, lost sales opportunities or lost customers. We understand it's essential to maximise productivity, which is why the Radan support subscription gives customers peace of mind with the assurance that should they ever require assistance we are here to help. Ensuring customers achieve maximum return on their investment is important to Radan.

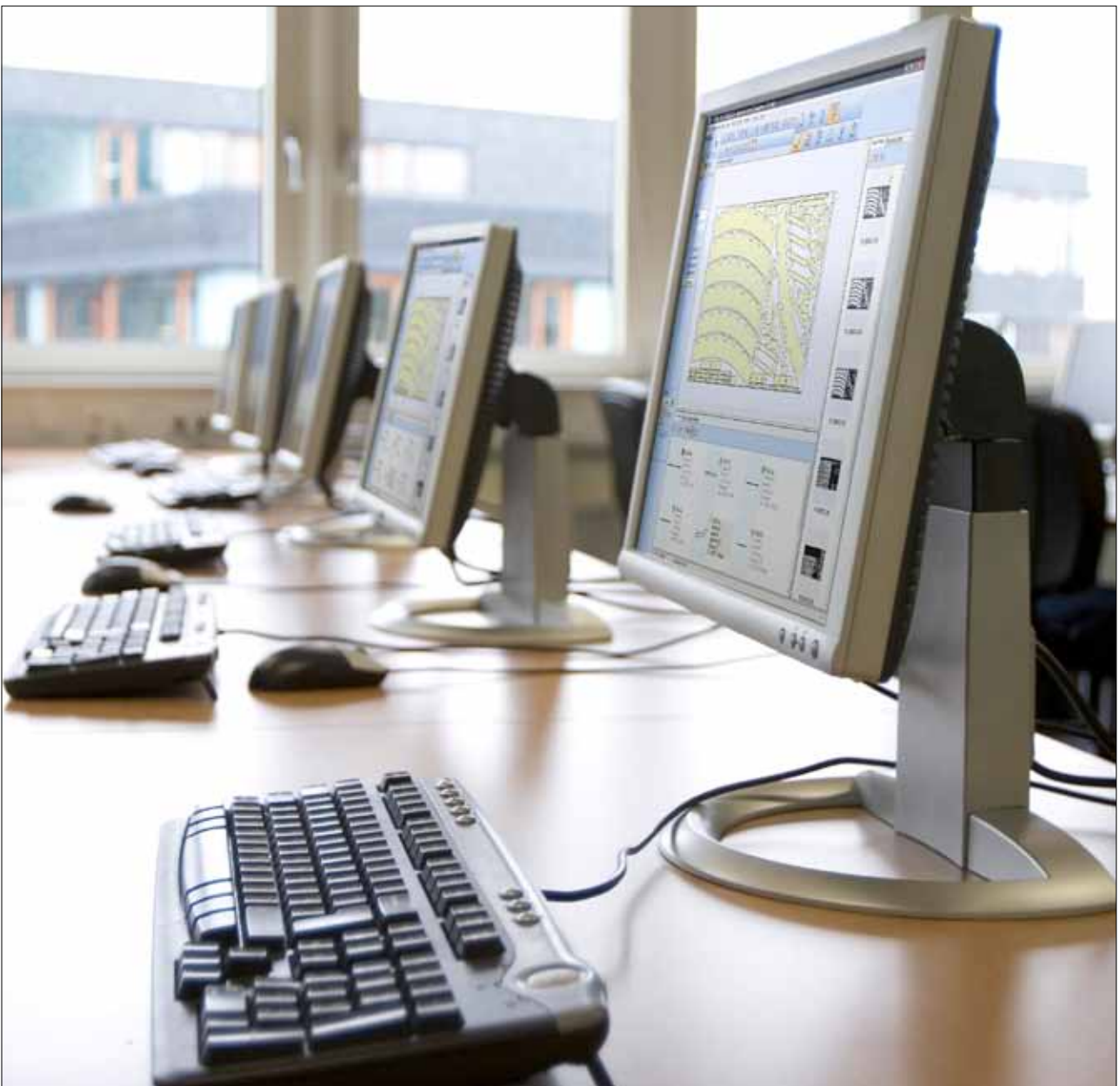

Radan Advantage

Support & maintenance plan

The Radan Help Desk is a dedicated team of highly experienced engineers who understand the industries that our customers work in, and the pressure they are under to maintain production at all times.

As well as the Help Desk, the support agreement also includes all major software releases, including service packs, to ensure that customers remain current with both software technology, and, equally important, the support of today's machine tool capabilities and current PC operating systems.

Global customer service portal

This is the fastest and most efficient method of logging a support case with our support team. You can easily attach files, set your own priority, add comments, and view the status of open and closed cases. Available 24/7, this site includes a knowledge base for searchable solutions, allows you to download software and documentation, update your company information, view license information, access to a discussion forum, and so much more.

Hotline

Gives Radan users direct contact with our experienced and knowledgeable engineers who understand today's manufacturing requirements.

E-support

Electronic documentation and questions enable Radan support engineers to view detailed information via email for rapid and accurate response.

Web rescue

Direct PC to PC support service allows our knowledgeable team of engineers to quickly and directly resolve issues in real time.

Expert on-site

Where required, we can send a Vero Support Engineer to your site, ensuring a speedy resolution to your issue.

Software updates

Receive annual software updates during the subscription period giving you the latest functionality and ensuring maximum productivity and efficiency.

There is one major software release per year plus service packs.

- Compatibility with the latest CAD systems supported by Radan
- Support from a dedicated team of engineers
- Access to Radan Global Customer Service Portal
- Technical Tip emails
- Download software releases and patches as soon as they are released
- Electronic notification of update releases
- Your Licence insurance for theft or damage

Bug fixes

Through the Customer Support Portal, you will be able to log and monitor any software bug and receive hot fixes.

Enhancement requests

Provide your valuable input into the modification and enhancement of existing product features and see them delivered through your software updates.

What our customers say

"Radan gives us flexibility to switch a job between laser and punch, or from punch to punch. Without it we'd have to use three pieces of software, and program online, meaning the machines would be unavailable for manufacturing during that time."

Jason Chauhan - JC Metal Works

"Undoubtedly, Radan has saved Hydram money, from the benefits of the integrated programming system across our machine tools through to efficient nesting and time saved with offline programming."

Andrew Jordan - Hydram

"We use Radan because it's so flexible and is the industry standard for the prototyping that we do."

Patrick Holt - NES Architectural

"Using Radan's Project Nesting function means it's quicker and more efficient to create new nests specific to each day's individual requirements every time."

Alex Mills, Information Systems Manager

Global presence

A network of over 150 partners in 45 countries

Part of the Vero Software Group, Radan is acknowledged as one of the world's leading PC based CAD/CAM solutions for the sheet metal industries with a proven track record of reliable product delivery.

Headquartered in England, Vero Software designs, develops, and supplies CAD/CAM/CAE software radically enhancing the efficiency of design and manufacturing processes, providing its customers with exceptional value through high productivity gains and significantly reducing time to market.

The company's world-renowned brands include Alphacam, Cabinet Vision, Edgecam, Machining STRATEGIST, PEPS, Radan, SMIRT VISI and WorkNC, along with the production control MRP system Javelin. Despite the diversity of application, these solutions have one thing in common: they all address the rising challenges of achieving manufacturing efficiencies and bring huge value to the operations in which they are deployed.

In the world of sheet metal, material utilisation is top priority. Radan significantly reduces inventory and realises true return on investment. Radan is a well established market leader providing applications that are essential to the design and manufacture (punching, profiling, nesting and bending) of sheet metal components and products.

Continual software development is core to the philosophy at Vero. We have an extensive development team striving to keep Radan at the leading edge of software capabilities.

Vero works in partnership with its customers – for the long term. Understanding the demands of their business and providing practical and innovative solutions. We listen to our customers' requirements and build answers into the software to meet their expectations now and for the future.

Service & support

Vero has a support network of engineers who understand your business through experience.

We will guide you through the modules and recommend the most appropriate combination of software, training and services that suits your needs.

The company has direct offices in the UK, Italy, France, Japan, USA, Brazil, Netherlands and China, while supplying products to more than 45 countries through its wholly owned subsidiaries and reseller network, with more than 135,000 global licenses installed.



Radan

Limpley Mill
Limpley Stoke
Bath
BA2 7FJ
United Kingdom

tel. +44 (0) 118 922 6666

email. info@radan.com

web. www.radan.com

radan